

### About Interroll

Established in 1959, Interroll has grown to become the world's leading supplier of key products for internal logistics. Whether boxes, pallets or soft goods are to be handled, no other supplier has such a complete product range on offer.

That is why system integrators, OEMs and operators select Interroll as their partner for their logistics business. Worldwide.

The Interroll global network ensures quick delivery and superior service for every local customer. We inspire our customers and provide opportunities for them to increase efficiency.



Interroll Carton Flow  
**Flexible and Easy  
Solution for Order Picking**

### [interroll.com](https://www.interroll.com)

Interroll reserves the right to modify the technical characteristics of all its products at any time. Technical information, dimensions, data and characteristics are indicative only.

# How to Increase Picking Performance

## High number of products to pick

### 📦 Pallet shelving

2 LEVELS → 6 DIFFERENT PRODUCTS

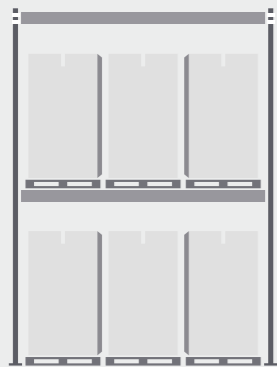

### 📦 Carton storage

5 LEVELS → 25 DIFFERENT PRODUCTS

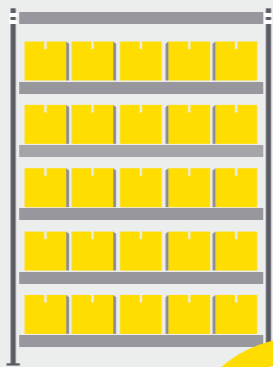

EXTRA PRODUCTS TO BE TAKEN

## Space Saving

### 📦 Carton shelving

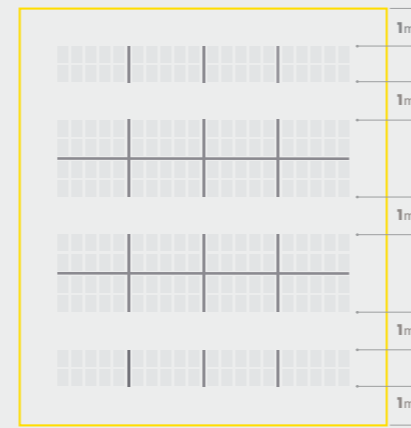

### 📦 Interroll Carton Wheel Flow

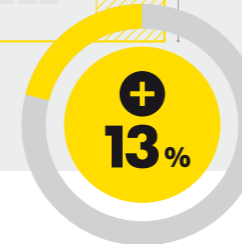

SPACE SAVING REDUCTION UP TO 13%

## Time Saving

### 📦 Carton shelving

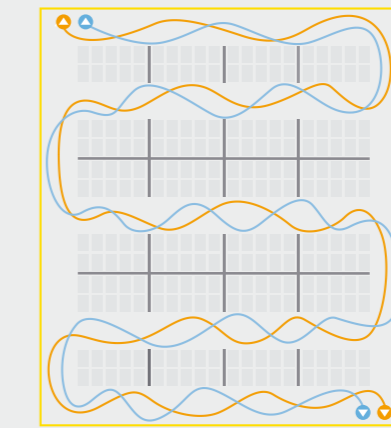

● PICKING ● REPLENISHMENT

### 📦 Interroll Carton Wheel Flow

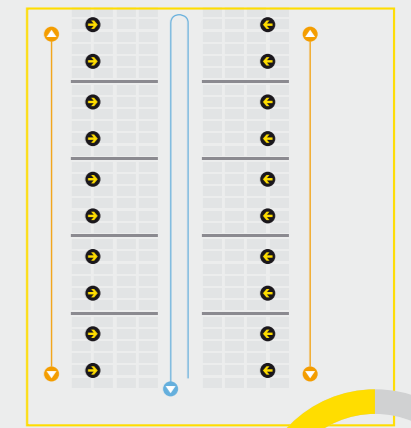

● PICKING ● REPLENISHMENT

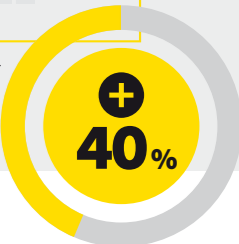

TIME SAVING REDUCTION UP TO 40%

Using gravity in logistics and distribution requires experience, engineering and expertise, which we have gained over the years in thousands of flow storage installations. Interroll's proven solutions for material handling and order processing for light loads is **compact, flexible** in use and **easy to install**.

When it comes to the planning of commissioning lines, you can **save time and space** with Interroll Carton Flow Solutions. Time savings result from **easy installation**, but also during operations, since **walking distances are reduced**.

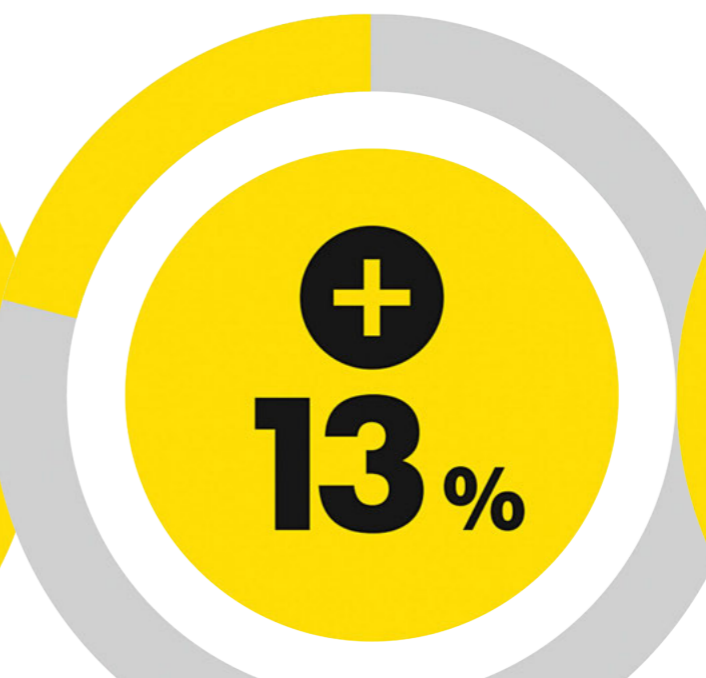



# Interroll Carton Wheel Flow



With the availability of various unloading types, the Interroll Carton Wheel Flow bed has been designed in an **ergonomic way** to allow **highest picking rates** and a **fast return on investment**. It is a perfect solution for unit loads with flat and rigid bottoms. With the universal connector, the Interroll Carton Flow beds can be installed

on most types of racking, regardless of the brand, even in cold storage areas down to **-30° C**.

With different **variants of unloading angles** — regular, 5°, 10° and 15° — the Carton Wheel Flow is the best way to **increase your picking rate to** up to 150 picks per hour in a safe way. The rate can be increased **up to 800** picks per hour when the Carton Wheel flow is combined with a pick-to-light system.

The Carton Wheel Flow solution is available in **various widths** of up to **3,600 mm** and **depths** of up to **4,552 mm** for configurable versions and up to **10,936 mm** for engineered solutions to meet all the requirements of common racking systems. In addition, **many options** — like guides, back-stops for automatic loading methods, breaking and loading plates and more — are available to fulfill your specific needs.

# Ergonomic picking

Drop out tray 15°

Drop out tray 10°

Drop out tray 5°

Unloading regular

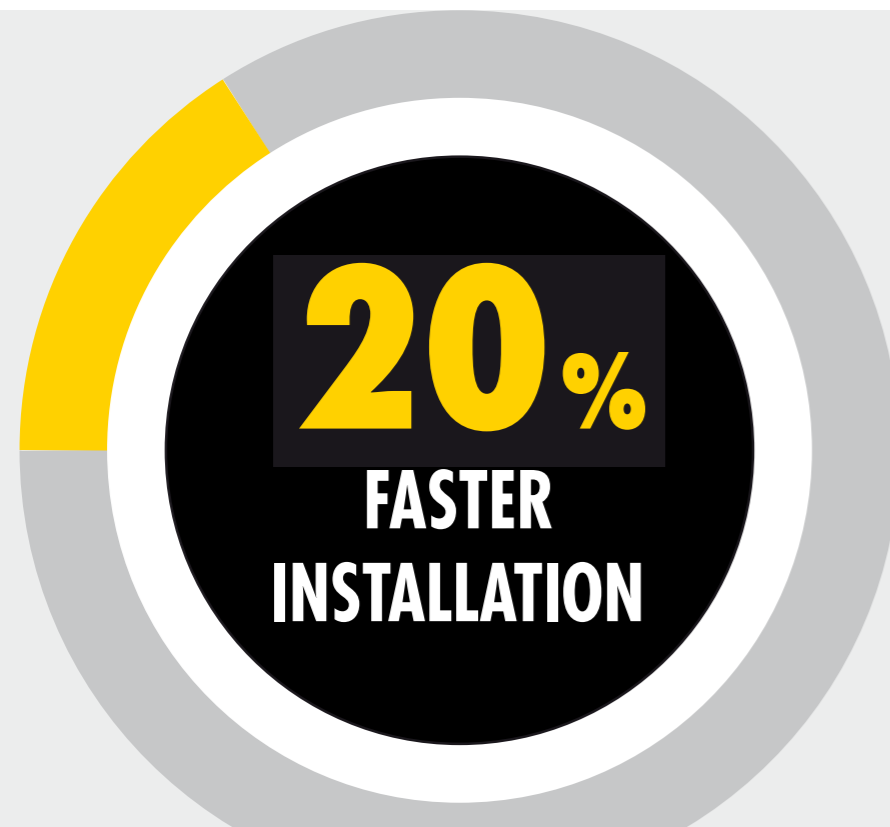

Learn how to install!

## Toolless track relocation.



# Some More Details...

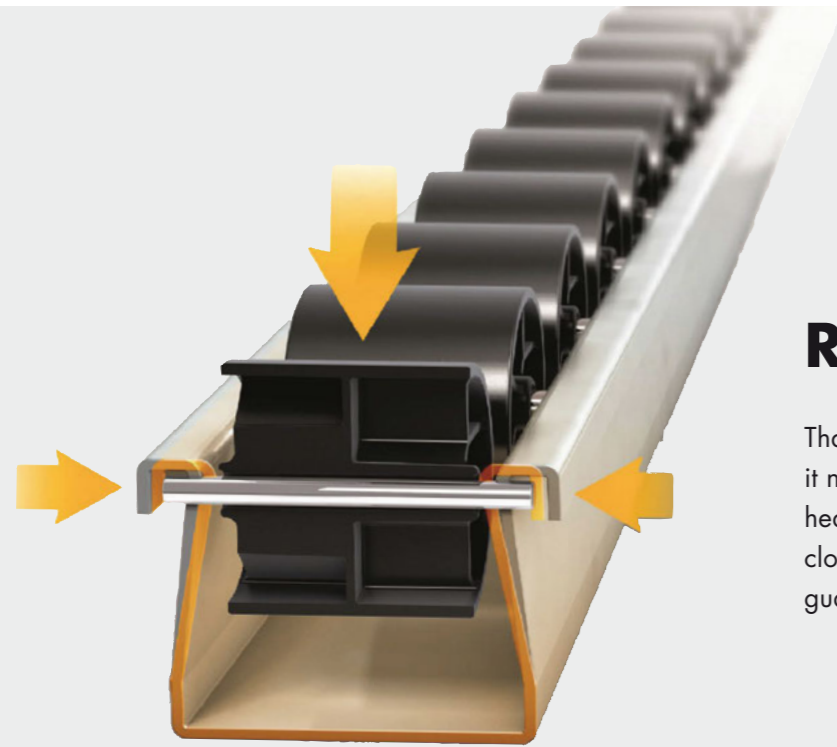

## Robustness

Thanks to the pyramidal shape of the profile, it never opens under heavy loads. The heavier the load, the better the profile is closing! Full width 3mm diameter steel axle guarantees the best flow capacity.

## Flexibility

The universal connector fits to all racking types. The bed slope adjustment is even faster thanks to the new clamp. The variable wheel pitch on the track allows optimum weight distribution. Wheels available in three colors.



Wheel pitch

Landing Side	Rolling Side
28	28
28	42
28	56
42	42
42	56
56	56

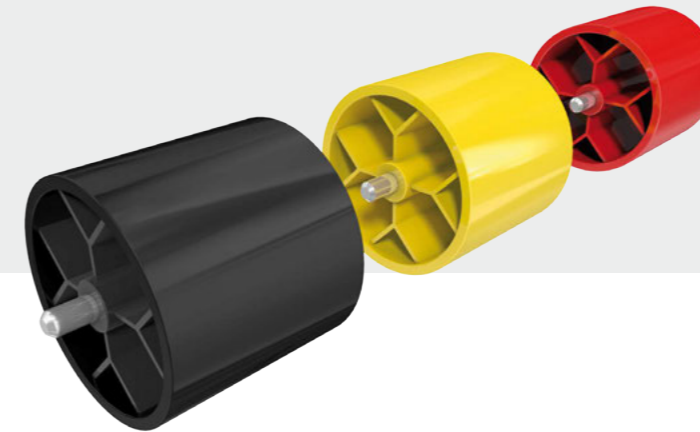

## Easiness

Easy placement of pick-to-light thanks to continuous end stop in front and rear.



## Accessories



Easy identification of channels by use of an entry guide, fast and easy tool-less positioning or repositioning.

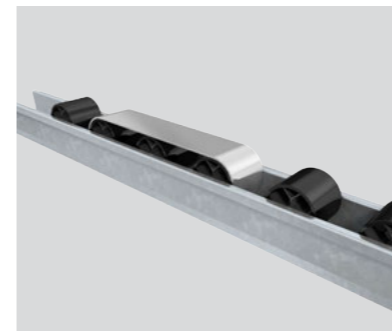

A very smooth stop of goods thanks to the braking clip. Recommended to use for deeper beds.

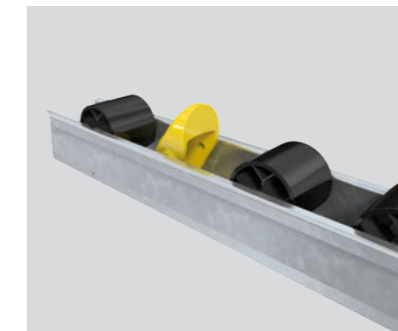

The backstop prevents boxes being forced off the rear of the bed during operator pushback picking operations.



The full length guide ensures a separation between channels along the bed and is easy to reposition if goods size vary.